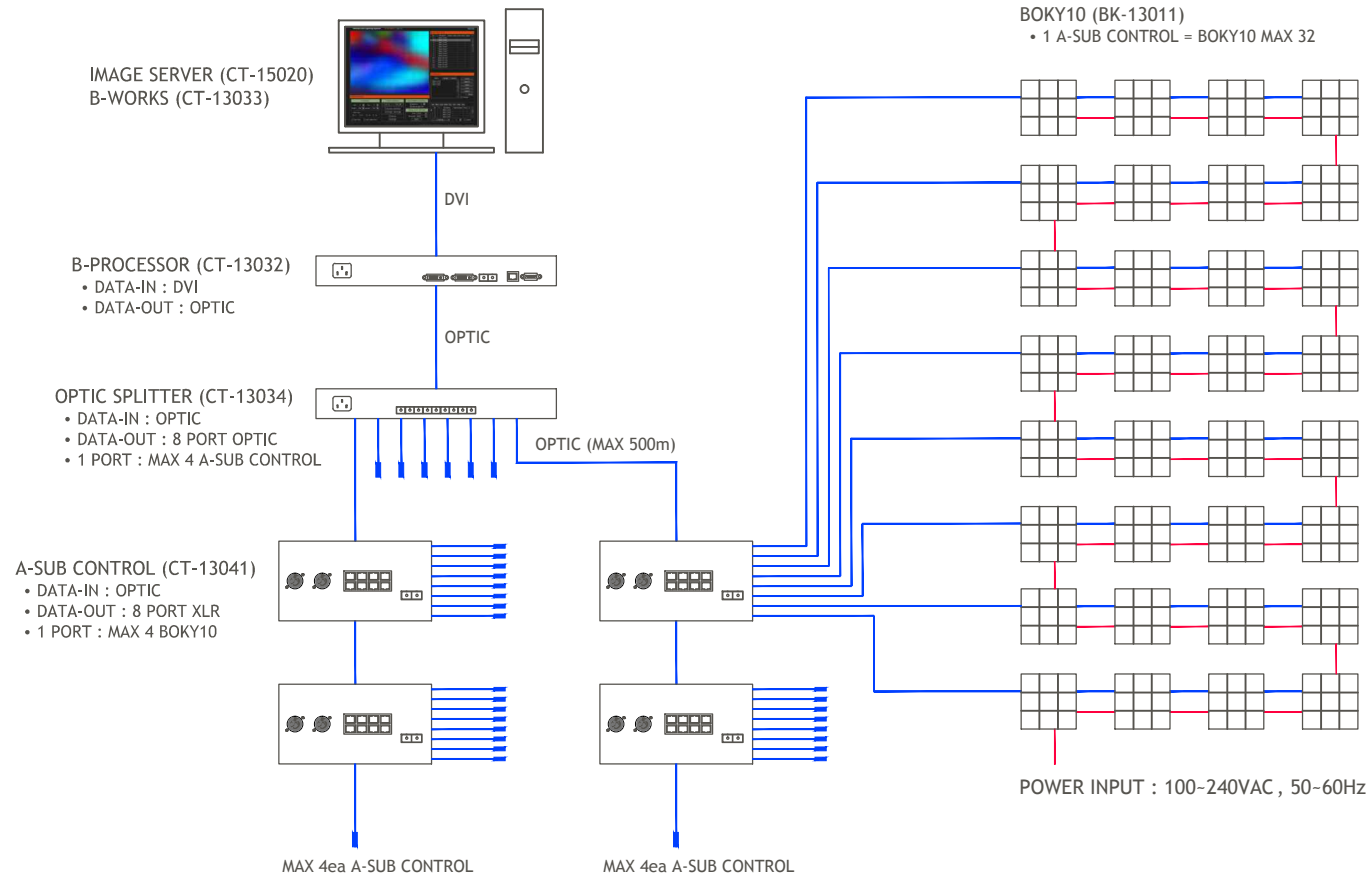

IMAGE-LED Lighting System

BOKY10 (BK-13011)



PROJECT NAME
TITLE NAME BOKY10 WIRING DIAGRAM
REVISIONS DATE 1. _____ DATE 2. _____ DATE 3. _____
APPROVED BY
CHECKED BY
DRAWING BY
MEMO
SCALE A3 : 1/10
DRAWING NO.
DATE 2010. 4
SHEET NO.

IMAGE-LED Lighting System

BOKY10 (BK-13011)

※ Example – BOKY10 60set<Width 6, Height 10>

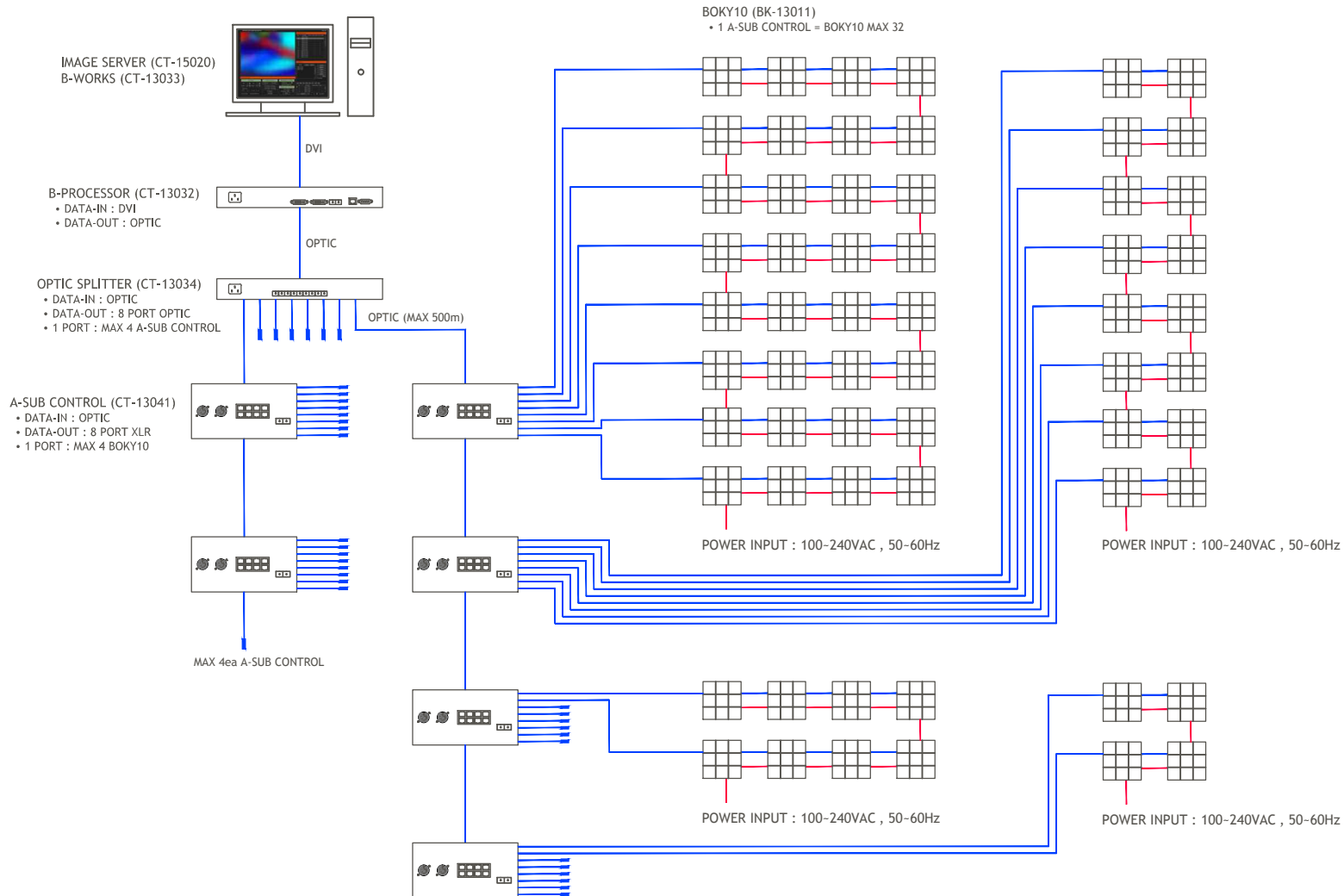

PROJECT NAME
TITLE NAME BOKY10 WIRING DIAGRAM
REVISIONS DATE 1. _____ DATE 2. _____ DATE 3. _____
APPROVED BY
CHECKED BY
DRAWING BY
MEMO
SCALE A3 : 1/10
DRAWING NO.
DATE 2010. 4
SHEET NO.